











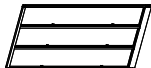
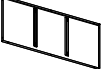

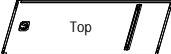
Six-door installation instructions

Part ID	Description	Illustration	Qty
1	Backplane		1
2	Left side plate		1
3	Right side plate		1
4	Front Frame		1
5	Top		1
6	Bottom		1
7	Middle-waisted		1
8	Middle Side Panel		2
9	Middle Side Panel		2
10	Big Shelf		2
11	Small Shelf		4
12	Door		6
13	Hanger		6
14	Screw		18
15	Next door shaft		3
16	Shaft door mat		6

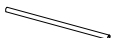
1

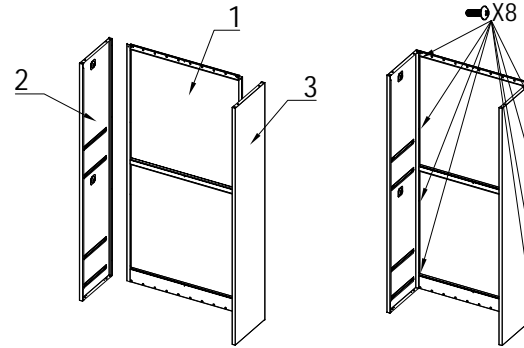

2

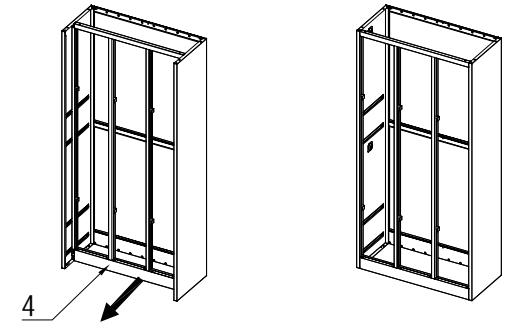

3

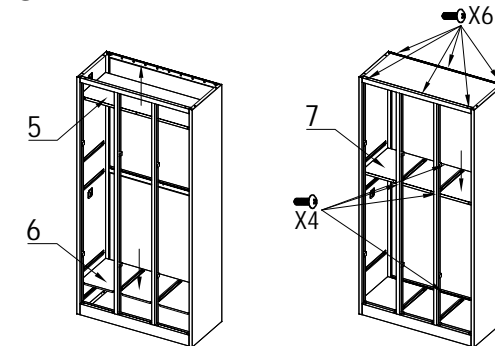

4

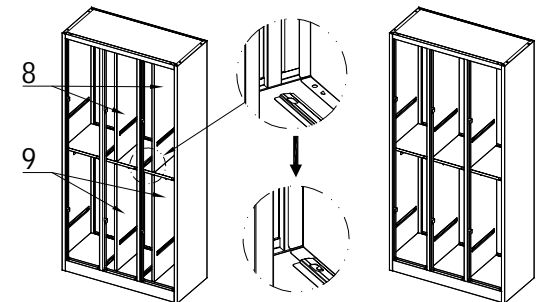

5

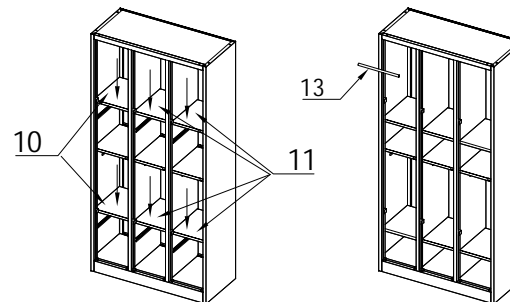

6

