

Cooker Hood

USER MANUAL

60M75

Warning notices: Before using this product, please read this manual carefully and keep it for future reference. The design and specifications are subject to change without prior notice for product improvement. Consult with your dealer or manufacturer for details. The diagram above is just for reference. Please take the appearance of the actual product as the standard.

THANK YOU LETTER

Thank you for choosing Midea! Before using your new Midea product, please read this manual thoroughly to ensure that you know how to operate the features and functions that your new appliance offers in a safe way.

CONTENTS







THANK YOU LETTER	01
SAFETY INSTRUCTIONS	02
SPECIFICATIONS	04
PRODUCT OVERVIEW	05
PRODUCT INSTALLATION	07
OPERATION INSTRUCTIONS	09
CLEANING AND MAINTENANCE	10
TROUBLESHOOTING	12
TRADEMARKS, COPYRIGHTS AND LEGAL STATEMENT	13
DISPOSAL AND RECYCLING	13
DATA PROTECTION NOTICE	14

SAFETY INSTRUCTIONS

Intended Use

The following safety guidelines are intended to prevent unforeseen risks or damage from unsafe or incorrect operation of the appliance. Please check the packaging and appliance on arrival to make sure everything is intact to ensure safe operation. If you find any damage, please contact the retailer or dealer. Please note modifications or alterations to the appliance are not allowed for your safety concern. Unintended use may cause hazards and loss of warranty claims.

Explanation of Symbols

	Danger This symbol indicates that there are dangers to the life and health of persons due to extremely flammable gas.
	Warning of electrical voltage This symbol indicates that there is a danger to life and health of persons due to voltage.
	Warning The signal word indicates a hazard with a medium level of risk which, if not avoided, may result in death or serious injury.
	Caution The signal word indicates a hazard with a low degree of risk which, if not avoided, may result in minor or moderate injury.
	Attention The signal word indicates important information (e.g. damage to property), but not danger.
	Observe instructions This symbol indicates that a service technician should only operate and maintain this appliance in accordance with the operating instructions.

Read these operating instructions carefully and attentively before using/commissioning the unit and keep them in the immediate vicinity of the installation site or unit for later use!

Contact an authorized service technician for repair or maintenance of this unit. The installation of this appliance must comply with national building or installation laws and regulations. Installation must be carried out by authorized personnel or specialists. Failure to follow these guidelines could result in hazardous conditions.

WARNING

- The instructions for Use apply to several versions of this appliance. Accordingly, you may find descriptions of individual features that do not apply to your specific appliance.
- This appliance is not intended for use by persons (including children) with reduced physical, sensory or mental capabilities, or lack of experience and knowledge, unless they have been given supervision or instruction concerning use of the appliance by a person responsible for their safety.
- Children should be supervised to ensure that they do not play with the appliance.
- This appliance can be used by children aged from 8 years and above and persons with reduced physical, sensory or mental capabilities or lack of experience and knowledge if they have been given supervision or instruction concerning use of the appliance in a safe way and understand the hazards involved. (EN 60335-1 & EN 60335-2-31)
- Children shall not play with the appliance. (EN 60335-1 & EN 60335-2-31)
- Cleaning and user maintenance shall not be made by children without supervision. (EN 60335-1 & EN 60335-2-31)
- If the supply cord is damaged, it must be replaced by the manufacturer or its service agent or a similarly qualified person in order to avoid a hazard.
- This appliance incorporates an earth connection for functional purposes only.
- There shall be adequate ventilation of the room when the range hood is used at the same time as appliances burning gas or other fuels (not applicable to appliances that only discharge the air back into the room).
- There is a fire risk if cleaning is not carried out in accordance with the instructions;
- Do not flame under the range hood.
- CAUTION: Accessible parts may become hot when used with cooking appliances.
- **The air must not be discharged into a flue that is used for exhausting fumes from appliances burning gas or other fuels (not applicable to appliances that only discharge the air back into the room).**
- **The minimum distance between the supporting surface for the cooking vessels on the hob and the lowest part of the range hood. (When the range hood is located above a gas appliance, this distance shall be at least 65 cm. If the instructions for installation for the gas hob specify a greater distance, this has to be taken into account. The distance of 65cm can be reduced for**
 - **non-combustible parts of range hoods, and**
 - **parts operating at safety extra low voltage, provided these parts do not give access to live parts if deformed)**
- Regulations concerning the discharge of air have to be fulfilled.
- The appliance uses 4 hob elements at most.
- The manufacturer will not be held liable for any damages resulting from incorrect or improper installation.
- Check that the mains voltage corresponds to that indicated on the rating plate fixed to the hood.
- For Class I appliances, check that the domestic power supply guarantees adequate earthing.
- Connect the extractor to the exhaust flue through a pipe of minimum diameter 120mm.

- This appliance is for indoor household use only.
- To protect against the risk of electrical shock, do not immerse the unit, cord or plug in water or other liquid.
- Please unplug before cleaning and maintenance the appliance .
- Use a soft cloth moisten with mild soap, and then use a dry cloth to wipe it again.
- The route of the flue must be as short as possible.

CAUTION

- If the instructions for installation for the gas hob specify a greater distance specified above, this has to be taken into account.
- The extractor hood has been designed exclusively for domestic use to eliminate kitchen smells.
- Never use the hood for purposes other than for which it has been designed.
- Never leave high naked flames under the hood when it is in operation.
- Adjust the flame intensity to direct it onto the bottom of the pan only, making sure that it does not engulf the sides.
- Deep fat fryers must be continuously monitored during use: overheated oil can burst into flames.
- Extension sockets are forbidden.
- Please cut off the power before maintenance.
- This appliance has been designed for home use only, and may cause danger if used in special occasions.

ATTENTION

- The cooker hood and its filter should be cleaned regularly according to the instruction.
- Switch off or unplug the appliance from the mains supply before carrying out any maintenance work.
- Clean the hood using a damp cloth and a neutral liquid detergent.

SPECIFICATIONS

Model	60M75
Voltage /Frequency	220V-240V-/50Hz
Rated power	293W
Lighting power	1.5W×2
Motor input power	290W
Diameter of air tube	150mm
Air flow	800m ³ /h
Noise	≤72dB(A)

PRODUCT OVERVIEW

Components

Ref.	Qty.	Product Components
1	1	Hood Body,complete with: Controls, Light, Blower,Filter.
2.1	1	Lower Decorative Chimney
2.2	1	Upper Decorative Chimney
3	1	Flange (optional)
4	1	Exhaust Pipe (optional)
5	2	The Activated Charcoal filter (optional)

Qty.	Documentation
1	Instruction Manual

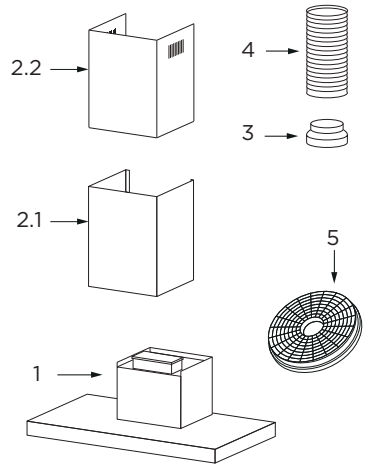

Ref.	Qty.	Optional Installation Components
10	7	Screws 5 x 50
11	7	Wall Plugs
12	6	Screws 4,2 x 9,5
20	1	Hood fixing bracket
21	2	Chimney fixing bracket

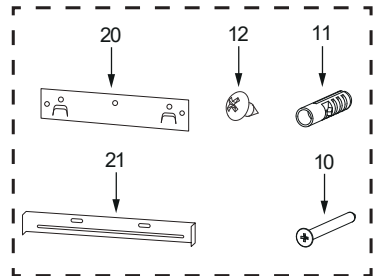

Dimensions

unit: mm

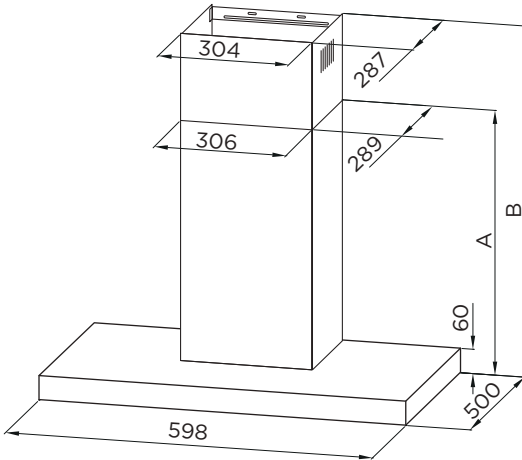
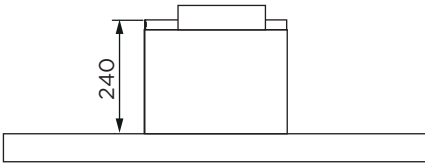
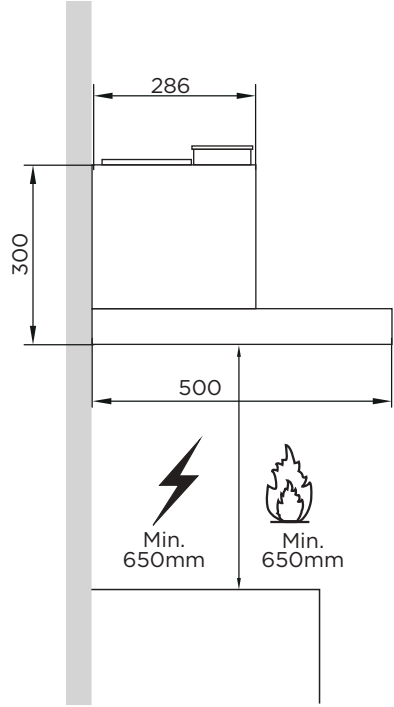
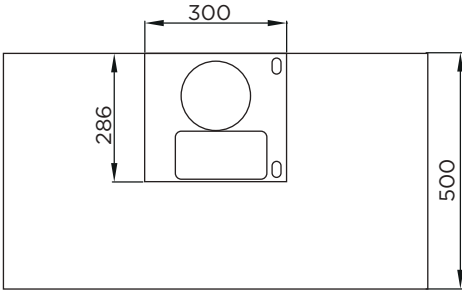

Option	Chimney	A	B	Height
1	400+390	450	485-820	450-820
2	500+490	550	585-1020	550-1020
3	600+590	650	685-1220	650-1220

PRODUCT INSTALLATION

Wall Drilling And Bracket Fixing

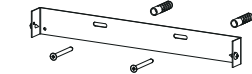
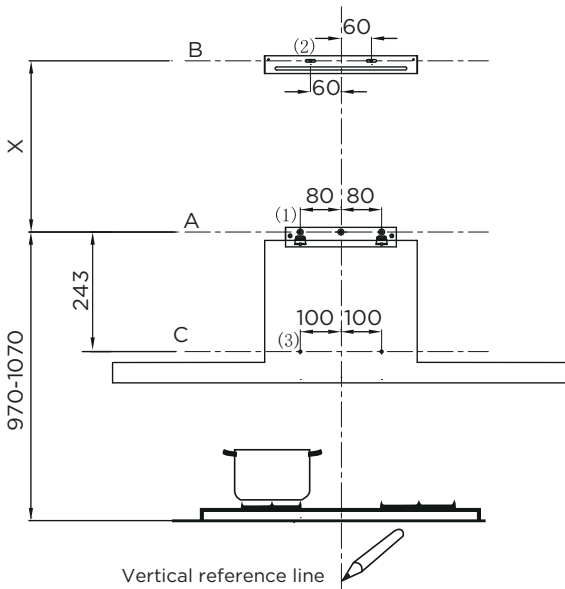

Option	Chimney	X
1	400+390	160-500
2	500+490	260-700
3	600+590	360-900

As a first step, proceed with the following drawings:

- A vertical up to the ceiling or up to the upper limit, at the center of the area in which the hood is to be fitted.
- A horizontal line A at 970 - 1070 mm above the cooker top.
- A horizontal line B at a X mm above the horizontal line A.
- A horizontal line C at a 243 mm below the horizontal line A .

Mark Points:

- Mark a point (1) on the horizontal line A, 80 mm to the vertical reference line.
- Repeat this operation on the other side and on the vertical reference line, checking that the three marks are leveled.
- Mark a point (2) on the horizontal line B, 60 mm to the vertical reference line.
- Repeat this operation on the other side, checking that the two marks are on the same horizontal line.
- Mark a point (3) on the horizontal line C, 100 mm to the vertical reference line. Repeat this operation on the other side , checking that the two marks are leveled.

Fix the brackets :

- Drill holes at the marked points with a $\Phi 10$ mm drill bit.
- Insert the Wall Plugs 11 into the holes.
- Fix the hood fixing bracket 20 with 3 screws 10 (5 x 50) at the horizontal line A.
- Fix a Chimney fixing bracket 21 with 2 screws 10 (5 x 50) at the horizontal line B.

Lower Decorative Chimney

- Fix the exhaust pipe on the hood body, connect chimney and hood body with 2 screws 12. connect chimney fixing bracket and chimney with 2 screws 12.

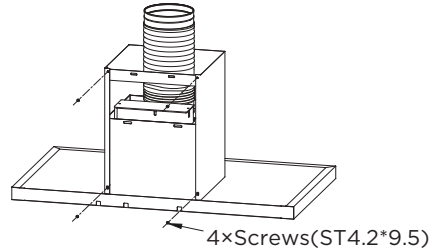

Hook The Hood Body

- Hook the hood body to the bracket 20.
- Level the hood body itself.
- Remove the filter from the inside of the hood body, fix the screws 10 to Wall Plugs 11 at the points (3).

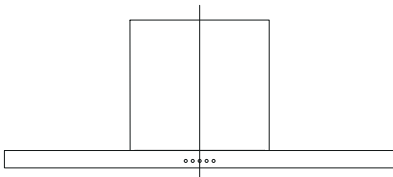

Right

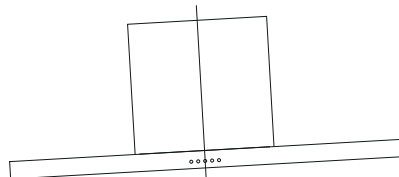

Wrong

Connections

When installing the ducted version, connect the hood to the chimney using either a flexible or rigid pipe $\Phi 150$ or $\Phi 120$ mm, the choice of which is left to the installer.

- If to install a $\Phi 120$ mm air exhaust connection, insert the reducer flange 3 on the hood body outlet.
- Fix the pipe 4 in position using sufficient pipe clamps (not supplied).
- Remove possible charcoal filters.

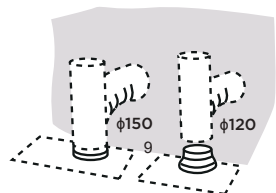

Upper Decorative Chimney

- Insert the upper decorative chimney 2.2 into the lower decorative chimney 2.1 and drag it up to the horizontal line B.
- Connect upper decorative chimney 2.2 and chimney fixing bracket 21 with 2 screws 12.

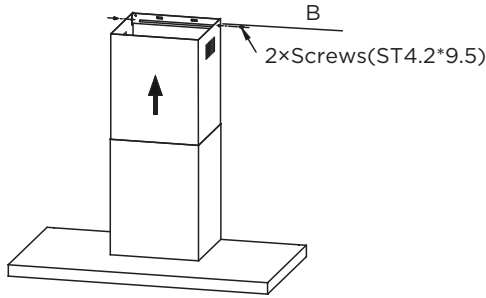

OPERATION INSTRUCTIONS

Speed Adjustment



Light



Minus



Digital screen



Plus



Power

After the hood is switched on, a beep sound heard and all key lights are lightened for 1s, indicating the hood has been powered on. Under the condition the hood power-on:

- Power Key: control the motor power, under standby state, press the “power” button, “power” key light is on, the motor starts up at low speed, digital screen displays setting 1; under power-on state, press the “power” button, enter 3-min-delay-shut-down state, setting switched to low speed, the power key flashes at one second interval, which means entering delay-shutdown state; under delay-shutdown state, press the “power” button, it’s shut down immediately (motor stops running).
- Light Key: independently control the light on and off free from the effect of other keys. Press it once, the light is on, meanwhile the light key light is on; press again, the light is off and light key light is off too.
- Plus (+) Key: valid under power-on state, press plus (+) key once, motor speed increased one setting, digital tube displays corresponding setting. When the plus (+) key is pressed down, plus (+) key light is on. When at the highest setting, only give out key touch sound, the setting no longer changes.
- Minus (-) Key: valid under power-on state, press “minus (-)” key once, motor speed decreased one setting, digital tube displays corresponding setting. When the “minus (-)”key is pressed down, “minus (-)”key light is on. When at the lowest setting, only give out key touch sound, the setting no longer changes.

CLEANING AND MAINTENANCE

Grease Filters

CLEANING METAL SELF-SUPPORTING GREASE FILTERS

- The filters must be cleaned every 2 months of operation, or more frequently for particularly heavy usage, and can be washed in a dishwasher.
- Remove the filters one by one pushing them towards the back side of the hood unit and simultaneously pulling downwards.
- Any kind of bending of the filters has to be avoided when washing them. Before fitting them again into the hood make sure that they are completely dry. (The color of the filter surface may change throughout the time but this has no influence to the filter efficiency).
- When fitting the filters into the hood pay attention that they are mounted in correct position the handle facing outwards.

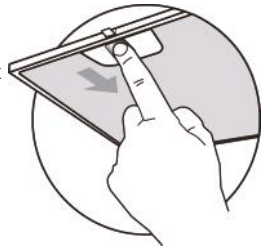

Activated Charcoal Filter (Recirculation Version)

- These filters are not washable and cannot be regenerated, and must be replaced approximately every 4 months of operation, or more frequently with heavy usage.

Replacing The Activated Charcoal Filter

- Remove the metal grease filters.
- Remove the saturated activated charcoal filter.
- Fit the new filters.
- Replace the metal grease filters.

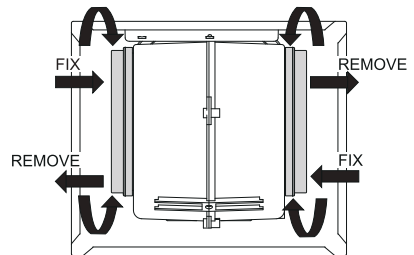



Lighting

LIGHT REPLACEMENT(Completed by professionals)

Replacing the light modules

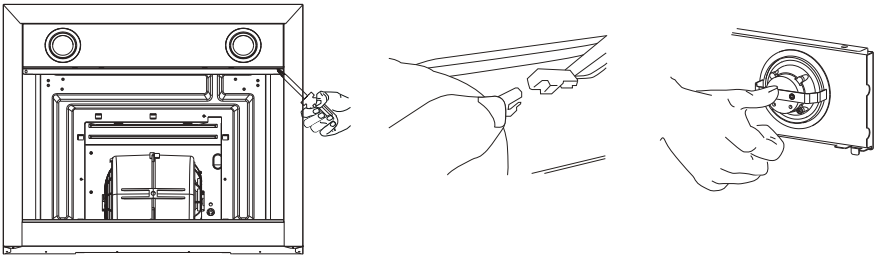
- Cannot replaced the light bulbs, the entire light module has to be replaced.
- When changing the light modules, the contacts are live.
- Before changing the light module(s), unplug the appliance from the mains or switch off the circuit breaker in the fuse box.
- Remove the grease filter and carefully remove the 2 screws from the front plate (a cross headed screwdriver will be needed to remove the screws).
- Disconnect the terminal of LED light.
- Press LED light on the back of the front plate, take the LED light out.
- Replace the lamp(commmercially available LED lamp (max.1.5W).



Lamp type	Max Power	Voltage	Picture	Lamp Cap	ILCOS D code
LED modules, separate ballast	1.5W	DC 12 V	 Square/Diameter: 70mm	---	DSR-1.5-S-70

- Press LED light on the front of front plate, install the LED light on the front plate.
- Connect the terminal of LED light and light leads.
- Carefully fasten the 2 screws on the front plate ,reinstall the grease filter.

TROUBLESHOOTING

Problem	Possible reason	Solution
Light on, but motor does not work	<ul style="list-style-type: none"> The blades are blocked. 	Check the blades
	<ul style="list-style-type: none"> The capacitor is damaged. 	Replace capacitor.
	<ul style="list-style-type: none"> The motor is damaged. 	Replace motor.
	<ul style="list-style-type: none"> The internal wiring of motor is cut off/disconnected. An unpleasant smell may be produced. 	Replace motor.
Both light and motor do not work	Apart from the above mentioned, check the following:	
	<ul style="list-style-type: none"> Light damaged. 	Replace lights.
	<ul style="list-style-type: none"> Power cord loose. 	Connect the wires as the electric diagram.
Oil leakage	<ul style="list-style-type: none"> Outlet and the air ventilation entrance are not tightly sealed. 	Take down the outlet and seal with glue.
Vibration	<ul style="list-style-type: none"> The blade, if damaged, can cause vibrating. 	Replace the blade.
	<ul style="list-style-type: none"> The motor is not tightly fastened. 	Fasten the motor tightly.
	<ul style="list-style-type: none"> The cooker hood is not tightly fixed. 	Fixed the cooker hood tightly.
Insufficient suction	<ul style="list-style-type: none"> The distance between the cooker hood and the cooker top is too large. 	Readjust the distance.
	<ul style="list-style-type: none"> Too much ventilation from open doors or windows. 	Choose a new place to install the appliance or close some doors / windows.
The machine inclines	<ul style="list-style-type: none"> The fixing screws are not tight enough. 	Tighten the fixing screw and make it horizontal.
	<ul style="list-style-type: none"> The hanging screws are not tight enough 	Tighten the hanging screw and make it horizontal.

TRADEMARKS, COPYRIGHTS AND LEGAL STATEMENT

 Midea logo, word marks, trade name, trade dress and all versions thereof are valuable assets of Midea Group and/or its affiliates (“Midea”), to which Midea owns trademarks, copyrights and other intellectual property rights, and all goodwill derived from using any part of an Midea trademark. Use of Midea trademark for commercial purposes without the prior written consent of Midea may constitute trademark infringement or unfair competition in violation of relevant laws.

This manual is created by Midea and Midea reserves all copyrights thereof. No entity or individual may use, duplicate, modify, distribute in whole or in part this manual, or bundle or sell with other products without the prior written consent of Midea.

All the described functions and instructions were up to date at the time of printing this manual. However, the actual product may vary due to improved functions and designs.

DISPOSAL AND RECYCLING

Important instructions for environment

Compliance with the WEEE Directive and Disposing of the Waster Product:
This product complies with EU WEEE Directive (2012/19/EU). This product bears a classification symbol for waster electrical and electronic equipment (WEEE).

This symbol indicates that this product shall not be disposed with other household wastes at the end of its service life. Used device must be returned to official collection point for recycling of electrical electronic devices. To find these collection systems please contact to your local authorities or retailer where the product was purchased. Each household performs important role in recovering and recycling of old appliance. Appropriate disposal of used appliance helps prevent potential negative consequences for the environment and human health.



Compliance with RoHS Directive

The product you have purchased complies with EU RoHS Directive (2011/65/EU). It does not contain harmful and prohibited materials specified in the Directive.

Package information

Packaging materials of the product are manufactured from recyclable materials in accordance with our National Environment Regulations. Do not dispose of the packaging materials together with the domestic or other wastes. Take them to the packaging material collection points designated by the local authorities.



DATA PROTECTION NOTICE

For the provision of the services agreed with the customer, we agree to comply without restriction with all stipulations of applicable data protection law, in line with agreed countries within which services to the customer will be delivered, as well as, where applicable, the EU General Data Protection Regulation (GDPR).

Generally, our data processing is to fulfil our obligation under contract with you and for product safety reasons, to safeguard your rights in connection with warranty and product registration questions. In some cases, but only if appropriate data protection is ensured, personal data might be transferred to recipients located outside of the European Economic Area.

Further information are provided on request. You can contact our Data Protection **Officer via MideaDPO@midea.com**. To exercise your rights such as right to object your personal data being processed for direct marketing purposes, please contact us via **MideaDPO@midea.com**. To find further information, please follow the QR Code.



make yourself at home



www.midea.com