

This single PDF contains two separate manuals:

**User Manual | Faucet Manual**

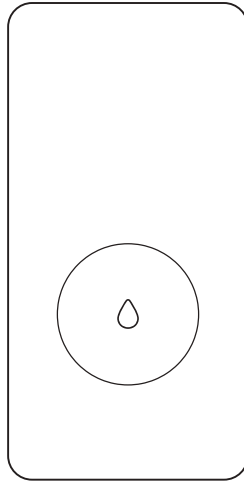

The diagram above is just for reference. Please take the appearance of the actual product as the standard.

WATER PURIFIER

# Instruction Manual

Model: MRO2008-600G

Before installing and operating your water purifier, please read the instruction manual carefully and keep it for future reference.

## 1. PRECAUTION

### 1-1 Safety Issues

Please note the following brief icons and rules for safe use of this product



#### Troubleshooting

When the machine fails, please disconnect the power and water source immediately



#### Maintenance

Never remove the parts on the machine to avoid leakage or damage



#### Avoid contact with children

Never have the machine operated by a child

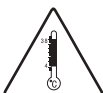

#### Temperature

Please use the product in a dry place with the temperature of 4-38°C



#### Electricity prevention

To avoid leakage of electricity.



#### Accessories and filters

To maintain the normal operation of the machine, be sure to use accessories and filters supplied by original company



#### Emergency call

For any help, please call the local sale service center or the national service hotline



#### Correct repair service

This machine can only be repaired by qualified personnel designated by this company



#### Avoid direct sunshine

Do not install the machine in a place exposed to direct sunshine



#### Anti-freeze

Never store or expose the product in an environment less than 0°C

1. This appliance can be used by children aged from 8 years and above if they have been given supervision or instruction concerning use of the appliance in a safe way and if they understand the hazards involved. Cleaning and user maintenance shall not be made by children unless they are older than 8 and supervised. Keep the appliance and its cord out of reach of children aged less than 8 years.
2. Appliances can be used by persons with reduced physical, sensory or mental capabilities or lack of experience and knowledge if they have been given supervision or instruction concerning use of the appliance in a safe way and understand the hazards involved.
3. Children shall not play with the appliance.
4. If the supply cord is damaged, it must be replaced by the manufacturer, its service agent or similarly qualified persons in order to avoid a hazard.
5. Do not store explosive substances such as aerosol cans with a flammable propellant in this appliance.
6. This appliance is intended to be used by expert or trained users in shops, in light industry and on farms, or for commercial use by lay persons.
7. The appliance is suitable for indoor use only.
8. WARNING: Keep ventilation openings, in the appliance enclosure or in the built-in structure, clear of obstruction.
9. WARNING: Do not use mechanical devices or other means to accelerate the defrosting process, other than those recommended by the manufacturer.
10. The appliance must not be immersed.
11. WARNING: To avoid a hazard due to instability of the appliance, it must be fixed in accordance with the instructions.
12. The appliance must not be cleaned by a water jet.
13. The appliance must not be immersed.

## 1-2 packing list

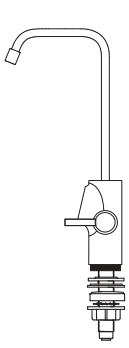

Smart Digital  
Faucet  
X 1 Set

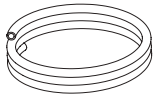

White 1/4" PE Tubing  
X 2m



Blue 1/4" PE Tubing  
X 2m

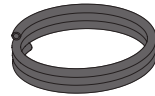

Red 1/4" PE Tubing  
X 2m

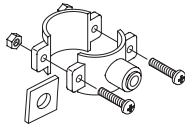

Drain Saddle  
X 1 Set



Lock Clip  
X 8 (2 Spare Clips)

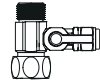

Feed Water Adapter  
X 1 Set

## 2. YOUR WATER PURIFICATION EXPERT

### 2-1 Product Overview

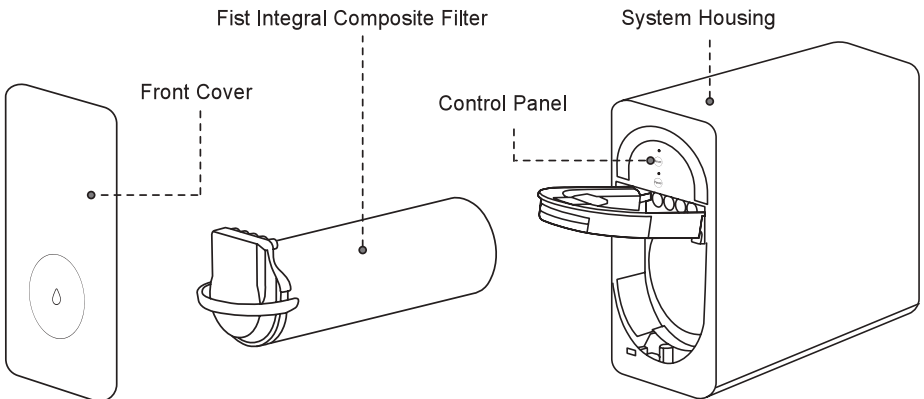

## 2-2 Control Panel

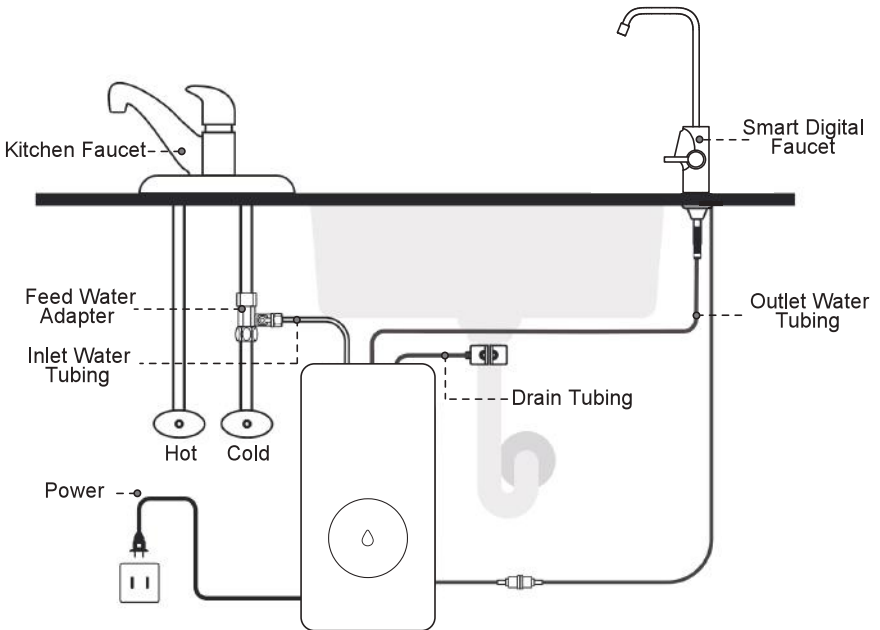
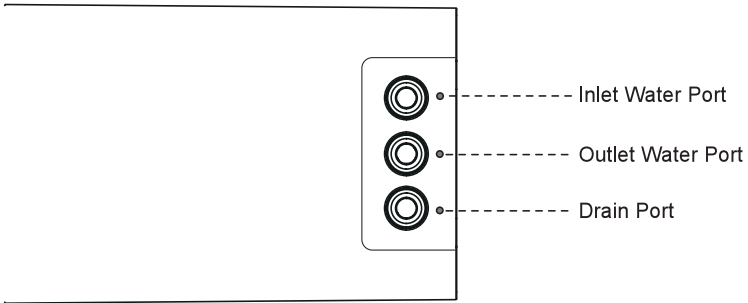
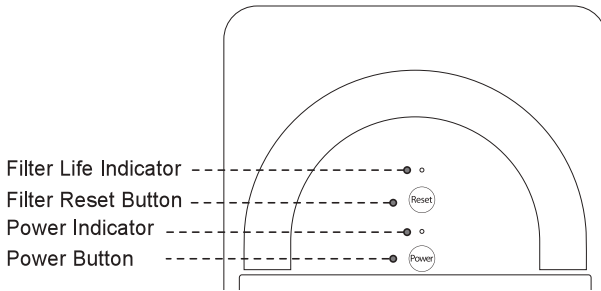

## 2-3 Installation Tips

### How to Use the Quick-Connect Fittings

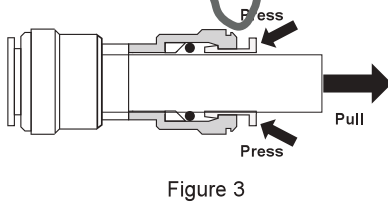
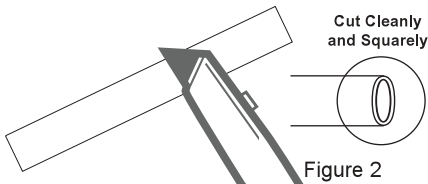
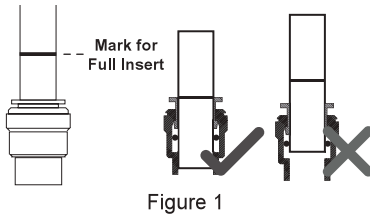

### To connect:

1. There is an existing mark (Figure 1) at the end of the tubing that you can use to confirm whether the tubing is fully inserted into the fitting. Push the tubing into the fitting until you reach the mark on the tubing.
2. If the tubing is not fully inserted, it will cause leakage. When the tubing is fully inserted, put the blue lock clip on the fitting. It will lock the tubing in place and prevent it from falling off.
3. If the tubing is too long, cut it to a suitable length using a sharp utility knife or pair of scissors. Cut the tubing squarely and cleanly (Figure 2). Make sure the tubing is fully inserted.

### To disconnect:

1. Remove the blue lock clip from the fitting.
2. Use your thumb and index finger to press down on the lock sleeve. Use your other hand to pull out the tubing from the fitting (Figure 3).  
**NOTE:** Please do not pull out the tubing directly, or else it will damage the fitting and cause leakage.

## How to Drill a Hole into Your Sink or Countertop (Optional)

### NOTE:

- Please confirm if there is an existing hole available to install the faucet. If not, please drill a hole in accordance with the following steps.
  - If the countertop is thicker than 7.5cm, the faucet cannot be installed. It's highly recommended to watch the YouTube video "How to Drill Faucet Holes" for a better understanding of the process. There is also a sticker for your reference when you drill the hole. Remember to wear safety glasses to protect your eyes while drilling the faucet hole.
1. Choose a diamond core bit for granite, and a carbide drill bit for stainless steel. Do not use a hammer drill on natural stone, glass, or ceramic.
  2. Glue the sticker to your sink or countertop, and drill a hole referring to the size shown on the sticker (1 $\frac{3}{8}$ ").
  3. Make an indent with a center punch on a stainless-steel sink before drilling to help guide the bit.
  4. Be careful when drilling on a porcelain sink, as it can be easily chipped. Apply downward pressure firmly to the bit until breaking through the surface.
  5. Starting at the lowest speed, hold the drill straight with firm pressure to prevent the bit from walking on the counter.
  6. Once breaking through the surface, swirl the drill a little to apply pressure in a circle evenly.

## 2-4 Installation Steps

### NOTE:

- Before installation, remove the RO system from the box and choose an easy-to-access area under the sink to place it. An adequate flat area is necessary to allow the system to rest securely. Do not lay it on its side, on its back, or upside down.
- Also before installation, ensure that there is a power outlet in the cabinet or on the wall connected to the lower cabinet space. Additionally, ensure that the system does not share the same power outlet as the garbage disposal.
- The RO system must be connected to the COLD water supply ONLY.
- Do not install the system where it will be exposed to direct sunlight or harmful chemicals, nor in any place where it may be damaged.
- Do not install the system near any heat source.
- Do not install the system outdoors.

### Step 1: Install the Feed Water Adapter

1. Shut off the water supply. Turn on the faucet to release the water pressure.

**NOTE:** Make sure the water has stopped before proceeding to the next step. Use a towel or bucket to catch any excess water.

2. Disconnect the cold water pipe from the cold water supply valve.

3. Connect the white 1/4" inlet water tubing to the feed water adapter and pop the lock clip on the fitting.

**NOTE:** Make sure it is fully inserted until you reach the mark on the tubing.

**NOTE:** The cold water pipe is 1/2", unscrew the converter from the A end of the feed water adapter, and then screw it on the B end of the feed water adapter (Figure 5). Next, follow step 4.

5. Twist the cold water pipe (with its washer) onto the feed water adapter and tighten it with an adjustable wrench.

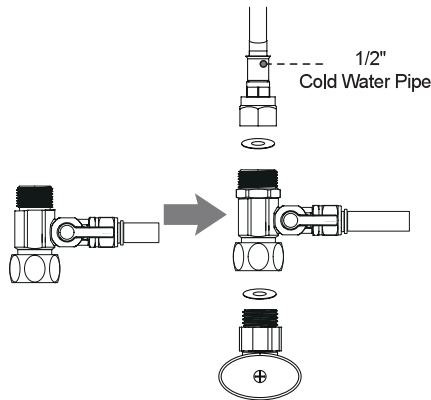
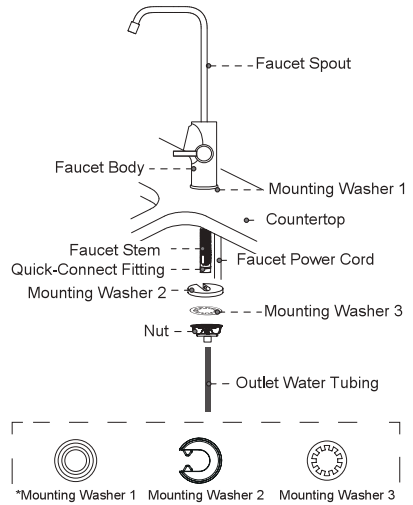

Figure 5

## Step 2: Install the Faucet

**NOTE:** If there is no hole in your kitchen sink or countertop, you have to drill one (1 3/8") or use the hole in the soap dispenser. Refer to Page 4.

1. Insert the faucet stem and power cord into mounting washer 1.
2. Insert the faucet stem and power cord into the hole on the countertop. Fix mounting washer 1 on the countertop.
3. Under the sink, put mounting washer 2 and 3 on the faucet stem. Slip on the nut and tighten it.
4. Insert one end of the blue 1/4" PE tubing into the quick-connect fitting on the faucet and pop in the lock clip on the fitting.



\*NOTE: Please use the black mounting washer that has the groove. You won't need the other black mounting washer.

## Step 3: Install the Drain Saddle

1. Stick the foam seal on the front plate of the drain saddle. Ensure that the hole of the foam seal is aligned with the hole of the front plate (Figure 6). Choose a spot on the drainpipe that is convenient for installing the drain saddle.

**NOTE:** It's recommended to install the drain saddle on the vertical drainpipe.

2. Drill a 1/4" hole in the drainpipe. Be sure not to penetrate the opposite side of the pipe.
3. Slip the front plate on one end of the tubing (without a mark) and insert the tubing into the drilled hole for about 0.6" (Figure 7).
4. Position the back plate on the drainpipe by tightening the screws and nuts evenly while leaving the tubing in the hole.
5. Pop the lock clip onto the fitting to secure the connection (Figure 8).

**NOTE:** In some areas, the drain tubing must be connected to the drainpipe through the air gap. Consumers must purchase air gap accessories separately.

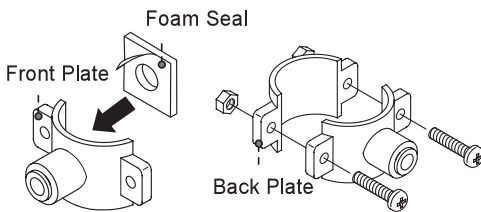

Figure 6

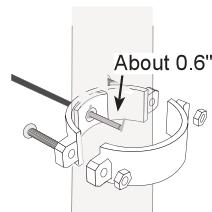

Figure 7

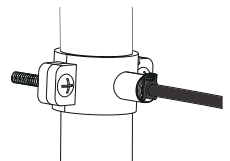
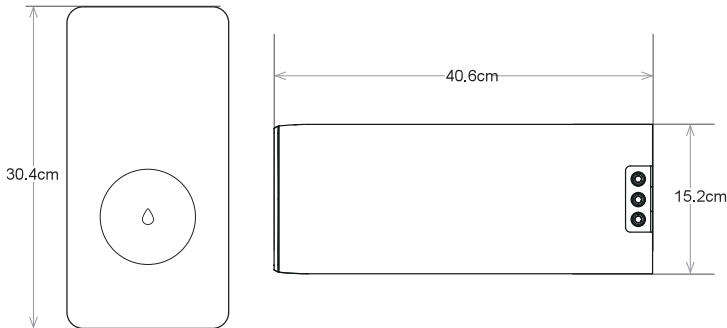

Figure 8

### Step 4: Position the RO System Housing

Ensure that there is sufficient space under the countertop to install the system (40.6cm\*15.2cm \*30.4cm). Set aside 5cm of space around the system to avoid placing the system against the cabinet.

**NOTE:** Position the front panel facing toward you, which will be convenient for future filter replacement and indicator checking. You can also adjust the placement direction of the RO system according to the layout under the sink.



### Step 5: Position the RO System Housing

#### NOTE:

- Confirm the tubing length you need first. Then cut the tubing if it is too long, referring to “How to Use the Quick-Connect Fittings” on page 4.
- Before connecting the PE tubing to the system, remove the plug from the water port. Press and hold the lock sleeve while pulling out the plug.

#### 1. Install the Inlet Water Tubing

- Identify the white 1/4" PE tubing that has been connected to the feed water adapter.
- Insert the other end of the tubing into the inlet water port and pop the lock clip on the fitting.

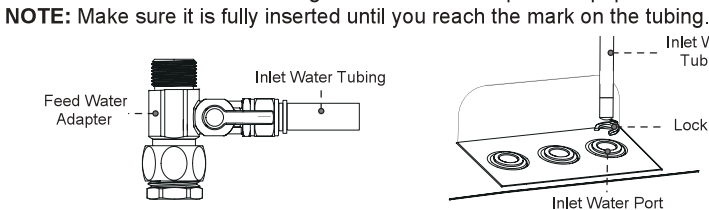

#### 2. Install the Outlet Water Tubing

- Identify the blue 1/4" PE tubing.
- Insert the other end of the tubing into the outlet water port and pop the lock clip on the fitting.

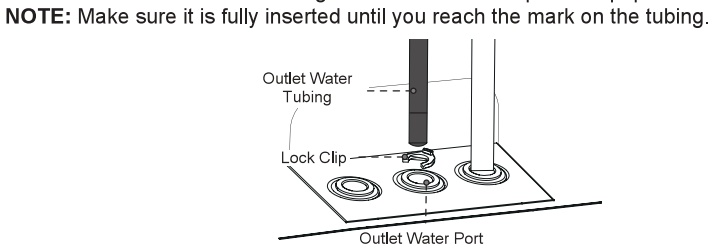

## Step 6: Install the Drain Tubing

- Connect the red 1/4" PE tubing to the drain saddle.
  - Insert the other end of the tubing into the drain port and pop the lock clip on the fitting.
- NOTE: Make sure it is fully inserted to the point where you reach the mark on the tubing.

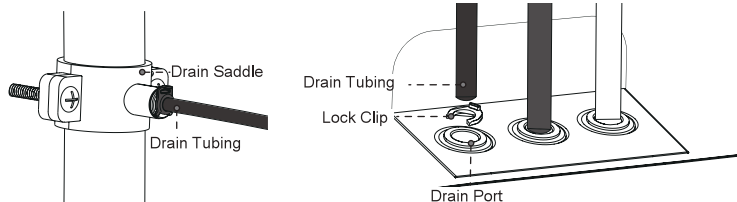

## Step 7: Start up the System

1. Turn on the cold water supply valve. Check for leaks.
2. Insert the power plug into the socket.

### NOTE:

- The system will be powered on and beep 5 times. The filter indicator light will flash 5 times and then stay on.
  - If the system can't be powered on after you insert the power plug, check the power under the sink, as this mostly occurs when the power under the sink is powered off. Also, check the connection between the power plug and the power outlet, and ensure that the system has been plugged correctly into the power outlet, as this may occur in a few cases. To test if there is a problem with the system itself, just pick up the system and try another power outlet. Please contact us if the system can't be powered on. We will help you figure it out.
  - Every time you power on the system, it will automatically flush for 25 seconds. The reset button and power button will flash alternately. If you turn on the faucet at this time, the outlet water flow will be slow. After flushing, the reset button and power button will be on, and the outlet water flow will return to normal.
3. Turn on the faucet, and allow it to run for 20 minutes. After flushing, the system is ready for use. The system will drain residual water after every use to ensure the system's service life and filtered water quality. Every time you turn on the faucet, the system will need some time to dispense water. There may be a 3-second delay before water dispenses, which is normal.

### NOTE:

- Be sure to carefully check the tightness of each part of the system while flushing. Ensure that all the tubing is installed correctly and completely. Make sure there are no leaks at the joints, fittings, valves, or tubing connections.
  - The water will be undrinkable during the flushing process. The water might appear black at first.
  - You will need to do the timekeeping for the 20-minute flushing yourself. Note that when the system continuously works for over 40 minutes, it will enter timeout protection mode. The filter indicator light will flash and the system will not be able to dispense water. Press the power button for 3 seconds. The filter indicator light will turn off. Then press the power button for 3 seconds. The system will return to normal.
4. Before turning off the faucet, make sure the flushing is complete and that there are no leaks in any of the parts.

### NOTE:

- When the system stops operation for 10 minutes, it will switch to self-flushing mode. The system will automatically flush for 20 seconds and then switch to standby mode. After 10 minutes, the system will not automatically flush again.
- When the system stops dispensing water for 24 hours, it will switch to self-flushing mode. The system will automatically flush for 90 seconds and then switch to standby mode. The timer will reset. After 24 hours, the system will not automatically flush again.

## 2-5 Display and Operation

### Section 1: Control Panel Display

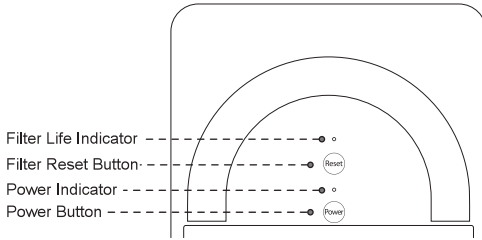

- Powering on mode: The filter life indicator flashes 5 times.
- Standby/Dispensing water mode: The filter life indicator stays on. When the filter expires, the filter life indicator flashes.
- Energy-saving mode: When the system stands by for 3 hours, it will switch to energy-saving mode. All indicators will be off. When you press a button or turn on the faucet, the system will exit energy-saving mode.

### Section 2: Filter Life Reminder

Fist Integral Composite Filter has a service life of 12 months. Please replace the filter when the situation shown in the figure occurs.

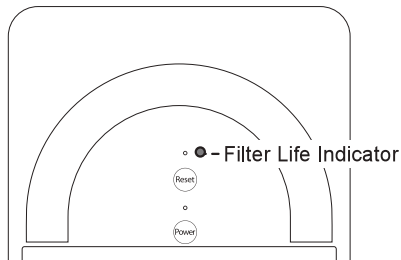

The filter indicator light flashes.

### Section 3: Filter Replacement Guide

Turn off the water supply and turn on the faucet. Press the power button for 3 seconds to turn off the power. Replace the filter according to the following steps.

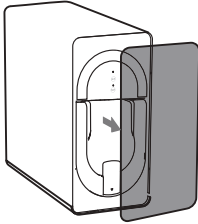

1. Remove the front cover.

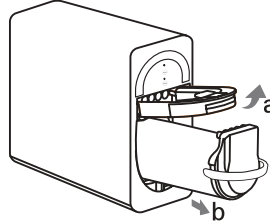

2. Pull up the locking handle (a) and use the filter handle to pull out the expired filter (b).

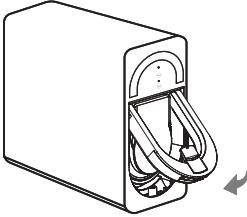

3. Insert a new filter and push down the locking handle. (You will have to press hard with your hands.)

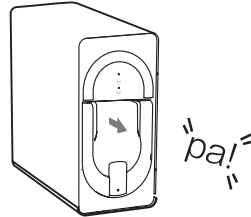

4. When you hear a snap and the locking handle stays in place, the filter is locked. The lock, locking handle, and front end must be on the same vertical line.

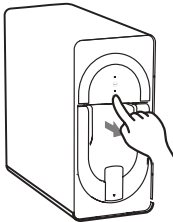

5. After replacing the filter, press the power button for 3 seconds. The indicator light will be on and you will hear a "ding" sound. (Note: The system will automatically flush for 25 seconds, and the reset button and power button will flash alternately. 25 seconds later, these two buttons will be on.) After flushing, press the reset button for 3 seconds. Release it when you hear a "ding" sound. The indicator light will change from flashing to constant.

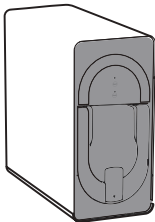

6. Put back the front cover and press the button to lock it. The filter reset is complete.

After resetting the filter, turn on the faucet and flush the system for 20 minutes until the water eventually turns clear.

**NOTE:** If you need to replace the filter when the life has not expired, press the reset button for 3 seconds. The filter indicator light will flash. Then press the button for 3 seconds again. The timer will reset. The filter reset is complete.

### 3. Maintenance

#### Caution:

- Do not crush, fold, knot, or damage the power cord.
- When the inlet water does not meet municipal tap water standards (including large amounts of sediment, excessive oxygen in the water, etc.), a pretreatment device should be installed before the installation of this system.
- The feed water pressure of this system is 0.1-0.6MPa. If the water pressure is lower or higher, install a pressurizer or pressure reducer accordingly.
- The flow rate will decrease when the ambient temperature is low, which is an inherent characteristic of the filter.
- When the system is dispensing water, there will be a slight vibration and noise, which is normal.
- This system is designed for indoor use only. A floor drain should be located within 1.5 meters of the system to avoid loss caused by water leakage and poor drainage.
- If the system will not be used for a long time, turn off the power and the feed water adapter. Flush the system for 5 minutes before using it again.

**NOTE:** In the event of a water outage or pipeline maintenance, turn off the power and the feed water adapter. When the water supply returns to normal, turn on other faucets to drain the sediment. Then turn on the feed water adapter. Otherwise, a large amount of sediment may block the filter. Replace and flush the filter regularly.

#### Installation Precautions

- Applicable water quality: municipal tap water.
- The feed water pressure of this system is 0.1-0.6MPa. When the water pressure is lower or higher, install a pressurizer or a pressure reducer accordingly.
- The recommended temperature range of the product is 4-38°C . Do not install the system where the ambient temperature and water temperature are higher than 40°C or below 0°C .
- Check whether the tubing connected to the system is incorrect and aging.
- Make sure all tubing is fully inserted to the point where you reach the mark on the tubing.
- Use only authorized parts and filters.
- Check the tightness of the feed water adapter and make sure there is no water leakage.
- When the quick-connect fitting leaks, do not replace only the lock clip. You must replace the entire quick-connect fitting.
- Do not omit any lock clips.
- Do not lay the system on its side, on its back, or upside down.
- Do not use a filter that has not been flushed. Flush the new filter for 20 minutes.
- Do not cut the tubing with tools other than a utility knife. Do not bend the tubing.
- Use the new quick-connect fittings that come with the system. The old quick-connect fittings cannot be reused.
- Do not insert the drain tubing into the sewer. It must be connected to the drainpipe using the drain saddle.
- Ensure that the power socket and adapter are in a dry place indoors to prevent moisture from accumulating in the system.

## 4. Troubleshooting

### • The System Cannot Be Powered on After You Insert the Power Plug

- a. Check the power under the sink, as this occurs primarily when the power under the sink is powered off. Also, check the connection between the power plug and the power outlet to ensure that the system has been correctly plugged into the power outlet. To test whether there is a problem with the system itself, simply pick up the system and try another power outlet. Please contact us if the system cannot be powered on. We will help you figure it out.

### • No Output Water from the Faucet

- a. The filter is expired: Check the filter life indicator to confirm whether the filter must be replaced; if it does, replace it immediately.
- b. Low water pressure: Check and confirm that the water pressure is between 0.1MPa and 0.6MPa.
- c. Water supply is off: Turn on the feed water adapter or the water supply valve.
- d. Incorrect filter installation: Reinstall the filter and make sure it is fitted into properly.
- e. A tubing is crimped: Check all the tubing and remove any crimps.

#### • Low Water Flow at the Faucet

- a. A tubing is crimped or there is a leak from the tubing connection: Check to ensure that all tubing is installed correctly and completely.
- b. The filter is expired: Check the filter life indicator to confirm whether the filter needs to be replaced; if it does, replace it immediately.
- c. Low water temperature: Be sure to use the system at a temperature of 4-38°C.
- d. The filter has been clogged: If you are using well water as the source, please ensure that the feed water has been through a pre-filtration system. Otherwise, large particles in the well water will easily clog the filter and shorten the filter life.

### • High TDS in the Filtered Water

When working properly, the system will provide a 90%+ TDS rejection rate (tested under standard laboratory conditions). If the TDS reading is high, the following are possible causes:

- a. The system hasn't been used in a while. Turn on the faucet and allow the water to run for a while. The TDS reading will return to normal.
  - b. The filter is expired: Check the filter life indicator to confirm whether the filter needs to be replaced; if it does, replace it immediately.
  - c. The drain tubing may be crimped or clogged: Check and remove the crimps. Realign the drain saddle and the drainpipe.
  - d. The source water may have a high TDS: Test the source water and the filtered water. The filtered water's TDS should be about 5%-10% of your source water's TDS. This is a normal range. If the source water has a high TDS, it may reduce the system's service life. When the filtered water's TDS creeps up to 15%-20% of the source water's TDS, please perform routine filter replacement.
- The System Hasn't Been Used in a While
- a. Deposits in the tubing may block the filter. Before using the system, turn on the regular tap and allow the water to run for a while. Turn on the filtered water faucet and flush the system.

### • Filtered Water from the Faucet Tastes Like Tap Water

- a. Incorrect tubing installation: Make sure the drain tubing is not connected to the faucet.
- b. The filter is expired: Check the filter life indicator to confirm whether the filter needs to be replaced; if it does, replace it immediately.

### • Water Leakage

- a. Check all the joints, fittings, and tubing connections to locate the leakage. Make sure the filter is well installed.

• **Loud Sound from the RO System**

The sound will not exceed 55 dB, which is a standard level for everyday life (55 dB is tested under standard laboratory conditions and the feed water pressure is between 0.1MPa and 0.6MPa).

A loud sound may be caused by any of the following:

- a. The system is not positioned in a flat area. Make sure the system is placed smoothly without shaking.
- b. The system is placed against the cabinet. Do not place the system against the cabinet. The system may vibrate when it is in operation.
- c. The water pressure is unstable. Check and confirm that the water pressure is between 0.1MPa and 0.6MPa. The sound will decrease when the water pressure becomes stable.

**5. TECHNICAL PARAMETERS**

<b>Model Number</b>	MRO2008-600G
<b>Total Filtration Capacity</b>	3600L
<b>Rated Voltage/Frequency</b>	100-240V~ 50/60Hz
<b>Rated Power</b>	85W
<b>Service Flow Rate</b>	1.5L/min
<b>RO Membrane Working Pressure</b>	0.4-0.8MPa
<b>Feed Water Pressure</b>	0.1-0.6MPa
<b>Feed Water Requirement</b>	Municipal Tap Water

**Filter Specifications**

Name	Filtration Media	Purpose	Quantity	Recommended Replacement Cycle
Fist Integral Composite Filter	First PP cotton layer	Filters out sediment, rust, suspended solids, and other large particles in water.	1	12 months
	Activated carbon block layer	Removes organic matters, chlorine, taste and odor.		
	Second PP cotton layer	Further removes suspended matter and other impurities.		
	Reverse osmosis membrane layer	With a filtration accuracy of 0.0001 μm, it intercepts organic matters and heavy metals in water.		
	Post-activated carbon block layer	Improves the taste of water.		

## 1 YEAR LIMITED WARRANTY

---

This is the only express warranty for the product and in lieu of any other warranty or condition.

This product is warranted to be free from defects in material and workmanship for a period of one year from the date of original purchase. During this period, your exclusive remedy is repair or replacement of this product or any component found to be defective, at our option; however, you are responsible for all costs associated with returning the product to us and our returning the product or component under this warranty to you. If the product or component is no longer available, we will replace with a similar one equal or greater value.

This warranty does not cover wear from normal use, and operation doesn't conform with the instruction manual, or damages to the product resulting from accident, alteration, abuse, or misuse. This warranty extends only to the original consumer purchaser, or gift recipient. Keep the original sales receipt, as proof of purchase is required to make a warranty claim. This warranty is void if product is used for other than single-family household use or subjected to any voltage and waveform other than as specified on the label.

We exclude all claims for special, incidental, and consequential damages by breach of express or implied warranty. All liability is limited to amount of the purchase price. Every implied warranty, including any statutory warranty or condition of merchantability or fitness for particular purpose, is disclaimed except to the extent prohibited by law, in which case such warranty or condition is limited to the duration of this written warranty.

This warranty gives you specific legal rights. You may have other legal rights that vary depending on where you live. Some states or provinces do not allow limitations on implied warranties or special, incidental consequential damages, so the foregoing limitations may not apply to you.

# Installation and User Manual

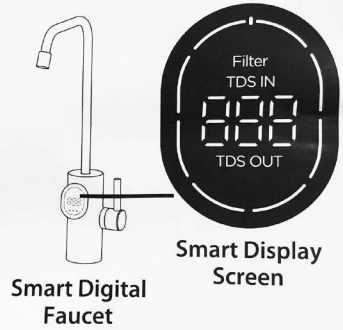
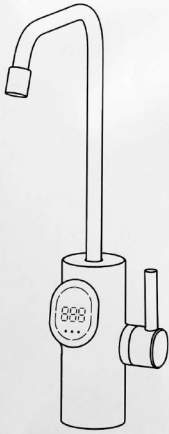

Figure 1

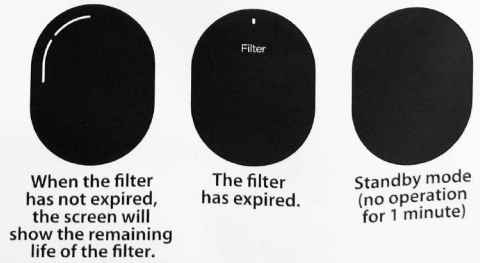

Figure 2

### 3. Filter life reminder (when the faucet is turned on)

- If the filter has not expired, every segment of the ring light will be on. Then, they will be off one by one, and the remaining segments indicate the life of the filter.

**Note:** When there are two segments of the ring light on the screen, the life of the filter remains about 4%-15% (40-150 gallons), which may vary based on your water conditions. It is recommended that you prepare a replacement filter in advance.

- If the filter has expired, the ring light will be off. Also, the filter replacement indicator will turn red and the screen will display "Filter" after flashing 3 times (Figure 3).

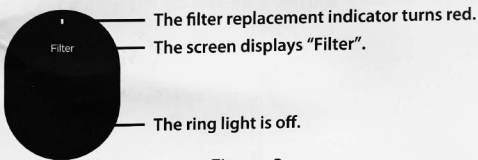

Figure 3

### 4. Malfunction display:

**E9:** If the faucet is powered on and does not receive the correct data for 5 seconds, the screen will display "E9" and then switch to standby mode after 1 minute.

**Note:** Check the power cord of the faucet to see whether it is plugged in. If not, plug it in. Check on whether the power cord is damaged. If so, please contact Waterdrop customer service.

**E6:** When the system continuously works for over 40 minutes, it will enter timeout protection mode. The screen will display "E6".

**Note:** Press the power button for 3 seconds. The filter indicator light will turn off. It will automatically flush for 25 seconds to power on the system. It will automatically flush for 3 seconds. If you turn on the faucet during flushing, the outlet water flow will be slow, which is normal.

**EA:** When the TDS display is abnormal, the screen will display "EA".

**Note:** You will need to unplug the power and plug it in again. If the problem has not been resolved, please contact Waterdrop customer service.

## Faucet Display

- The system is powered on: All indicators flash 5 times (Figure 1).
- The faucet is turned off: When the RO system is powered on, the screen will show the filter's status. If there is no operation for 1 minute, the screen will switch to standby mode (Figure 2).

## Install the Faucet

**Note:** If there is no hole in your kitchen sink or countertop, you have to drill one (1") or use the hole from the soap dispenser.

- Insert the faucet stem and power cord into mounting washer 1.
- Insert the faucet stem and power cord into the hole on the countertop. Fix mounting washer 1 on the countertop.
- Under the sink, put mounting washer 2 and 3 on the faucet stem. Slip on the nut and tighten it.
- Insert one end of the blue 1/4" PE tubing into the quick-connect fitting on the faucet and pop in the lock clip on the fitting.

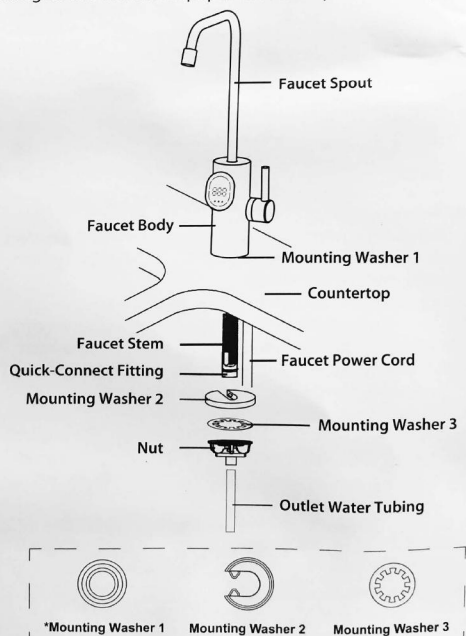

\*NOTE: Please use the black mounting washer 1 that has the groove. You won't need the other black mounting washer.