

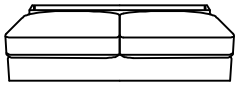

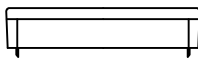



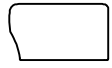
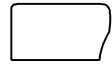

# Assembly Instruction

## COMPONENT LIST

NO.	DRAWING	QTY	NO.	DRAWING	QTY
A		1	B		1
C		1	D		1
E		1	F		1
G		4	H		2
I		8	J		1
K		1	L		2

Step1.

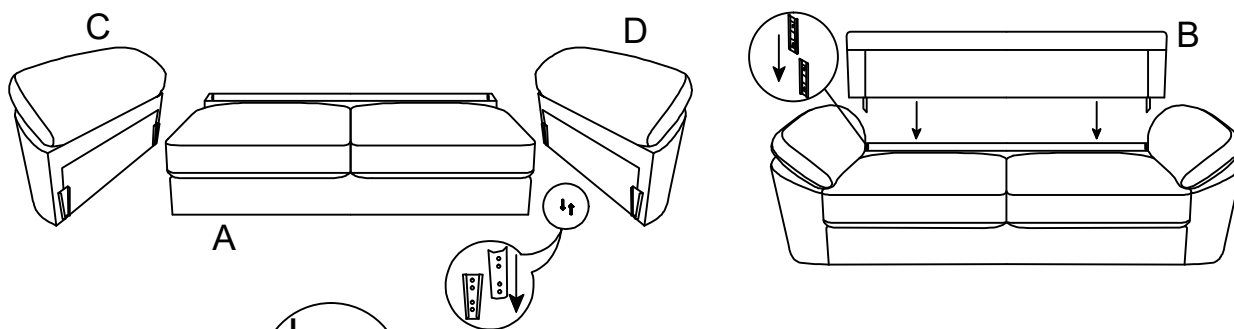

Step2.

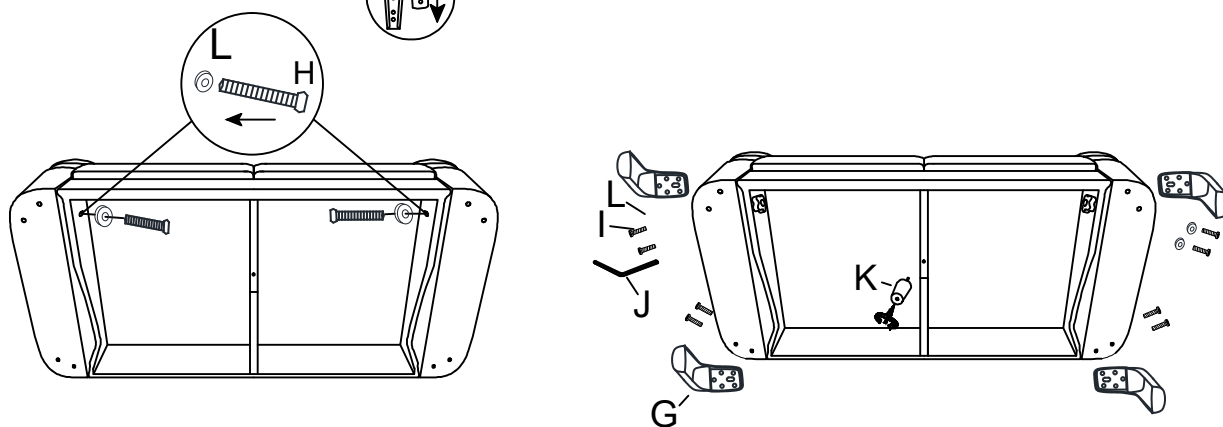

Step3.

